

PRODUCTO DE POLÍMERO

MOSAICSPLANAS

>> ALFEIZARES

con tacón y plano con goterón

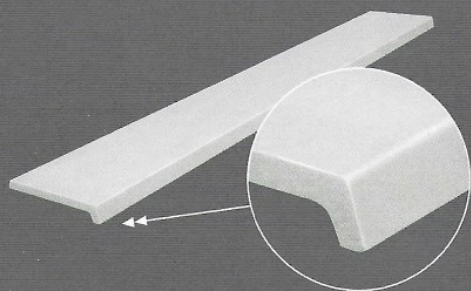

CARACTERÍSTICAS

BASE: Grava + anclaje.
COTAS: En centímetros.

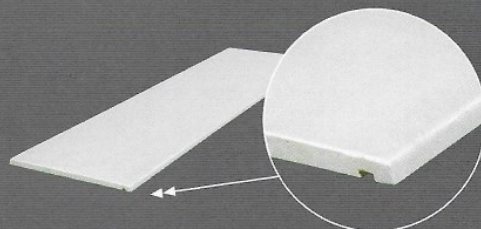

UTILIDADES

Formación de ventanas.
Decoración de la fachada del inmueble.

COLORES *  BLANCO  GRIS  TOSTADO  NEGRO

>> CON TACÓN

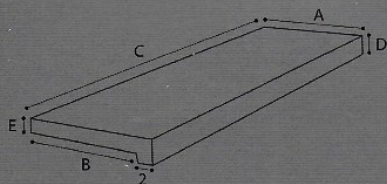

A	B	D	E
16	14	3,8	1,8
20	18	3,8	1,8
22	20	3,8	1,8
26	24	3,8	1,8
28	26	3,8	1,8
32	30	3,8	1,8
36	34	3,8	1,8
42	40	3,8	1,8
46	44	3,8	1,8
60	58	3,8	1,8

>> PLANO CON GOTERÓN

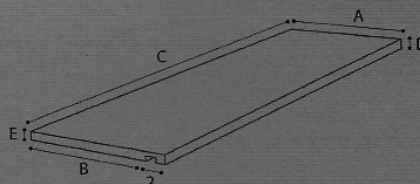

A	B	D	E
16	14	1,8	1,6
20	18	1,8	1,6
22	20	1,8	1,6
26	24	1,8	1,6
28	26	1,8	1,6
32	30	1,8	1,6
36	34	1,8	1,6
40	38	1,8	1,6
77	75	1,8	1,6

NOTA: La longitud (c) máxima de cada pieza será variable según la anchura.

* Se fabrica en cualquier color.

www.mosaicsplanas.com

 planas@mosaicsplanas.com  972 840 216

PRODUCTO DE POLÍMERO

MOSAICSPLANAS

>> ALBARDILLAS con goterón

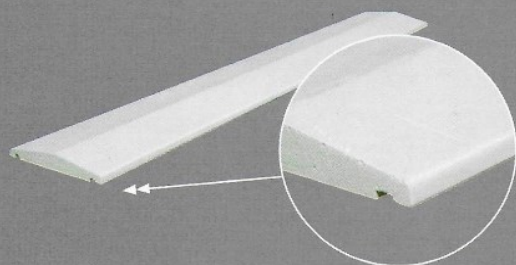

CARACTERÍSTICAS

BASE: Grava + anclaje.
COTAS: En centímetros.

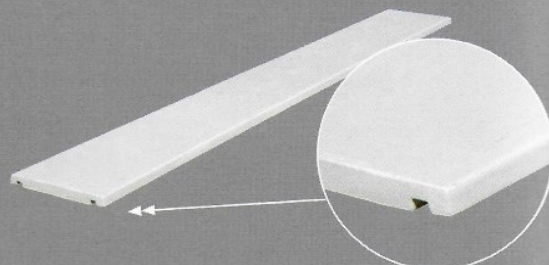

UTILIDADES

Formación de muros.
Decoración de la fachada del inmueble.

COLORES *  BLANCO  GRIS  TOSTADO  NEGRO

>> A DOS AGUAS

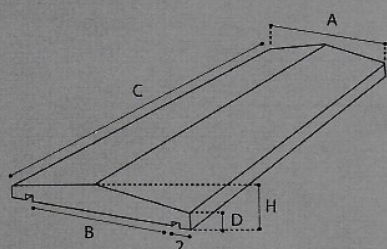

A	B	C	D	H
18	14	150	1,8	3,5
20	16	150	1,8	3,5
26	22	150	1,8	3,5
32	28	150	1,8	3,5
36	32	150	1,8	3,5
42	38	150	1,8	3,5

>> PLANA

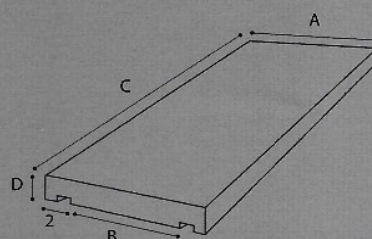

A	B	D
16	12	1,8
20	16	1,8
22	18	1,8
26	22	1,8
28	24	1,8
32	28	1,8
36	32	1,8
40	36	1,8
77	73	1,8

NOTA: La longitud (c) máxima para albardilla PLANA será variable según la anchura.
* Se fabrica en cualquier color.

www.mosaicsplanas.com

 planas@mosaicsplanas.com

 972 840 216

PRODUCTO DE POLÍMERO

MOSAICPLANAS

>> ALBARDILLA en U

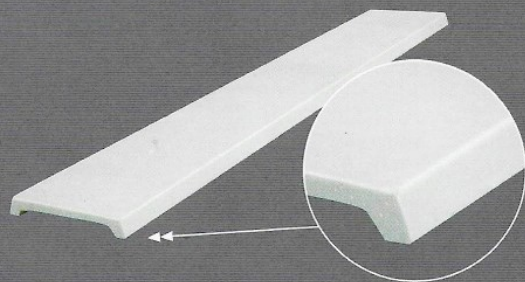

CARACTERÍSTICAS

BASE: Grava + anclaje.
COTAS: En centímetros.

UTILIDADES

Formación de muros.
Decoración de la fachada del inmueble.

COLORES *  BLANCO  GRIS  TOSTADO  NEGRO

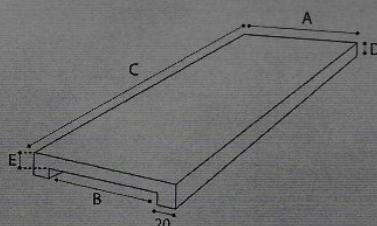

>> CON TACÓN



A	B	C	D	E
18	14	150	3,8	1,8
20	16	150	3,8	1,8
22	18	150	3,8	1,8
26	22	150	3,8	1,8
28	24	150	3,8	1,8
32	28	150	3,8	1,8
36	32	150	3,8	1,8
40	36	150	3,8	1,8
50	46	100	3,8	1,8
56	52	100	3,8	1,8
60	56	100	3,8	1,8
78	74	100	3,8	1,8
140	136	100	3,8	1,8

* Se fabrica en cualquier color.

www.mosaicsplanas.com

 planas@mosaicsplanas.com  972 840 216

PRODUCTO DE POLÍMERO

MOSAICSPLANAS

>> CUBREPILARES

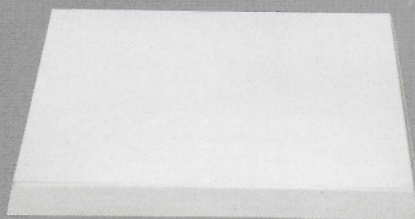

CARACTERÍSTICAS

BASE: Grava + anclaje.
COTAS: En centímetros.

UTILIDADES

Decoración de pilares.

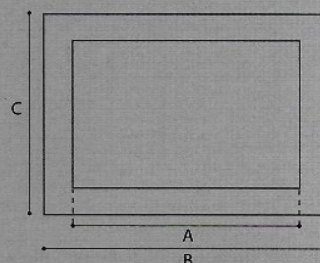
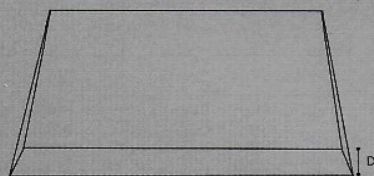

COLORES *  BLANCO  GRIS  TOSTADO  NEGRO



B	A	D
35 X 35	31 X 31	3,8
40 X 40	36 X 36	3,8
50 X 50	46 X 46	3,8
60 X 60	56 X 56	3,8
48 X 60	44 X 56	3,8
26 X 26	22 X 22	3,8

* Se fabrica en cualquier color.

www.mosaicsplanas.com

 planas@mosaicsplanas.com  972 840 216

PRODUCTO DE POLÍMERO

MOSAICSPLANAS

>> CABEZALES

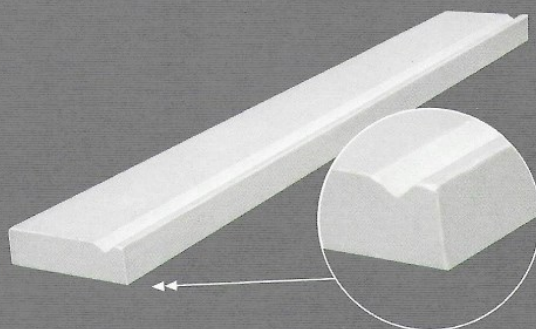

CARACTERÍSTICAS

BASE: Grava + anclaje.
COTAS: En centímetros.

UTILIDADES

Formación de ventanas.
Decoración de la fachada del inmueble.

COLORES *



BLANCO



GRIS



TOSTADO



NEGRO

>> CON GOTERÓN

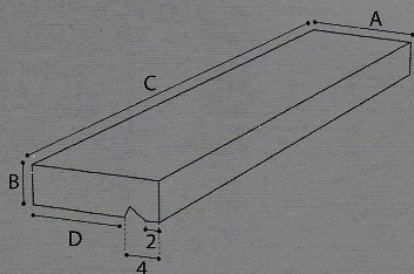

A	B	D
16	5	12
22	5	18

>> SIN GOTERÓN

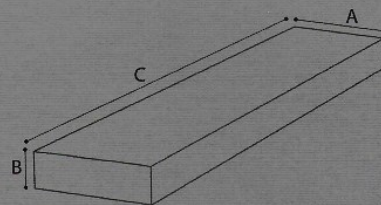

A	B
11	5
16	5
22	5

NOTA: La longitud máxima de cada pieza será variable según la anchura.

* Se fabrica en cualquier color.

www.mosaicsplanas.com



planas@mosaicsplanas.com



972 840 216

PRODUCTO DE POLÍMERO

>> GÁRGOLA

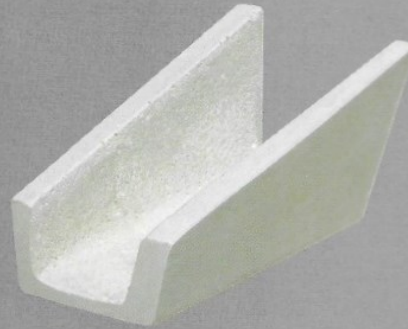

CARACTERÍSTICAS

BASE: Grava + anclaje.
COTAS: En centímetros.

UTILIDADES

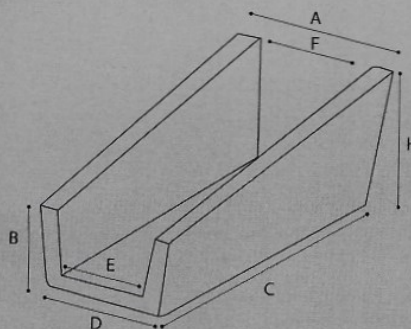

Decoración de la fachada del inmueble.

COLORES *  BLANCO  GRIS  TOSTADO  NEGRO



A	B	C	D	E	F	H
15	6	30	10	8	12	14

www.mosaicsplanas.com

 planas@mosaicsplanas.com  972 840 216

>> ALFEIZARES

con tacón y plano con goterón

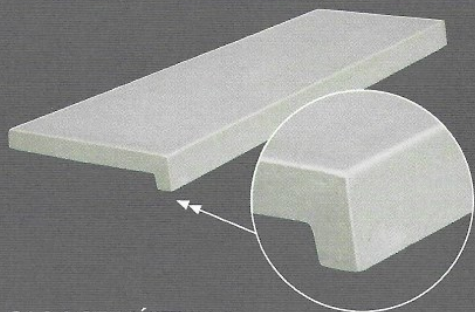

CARACTERÍSTICAS

COTAS: En centímetros.

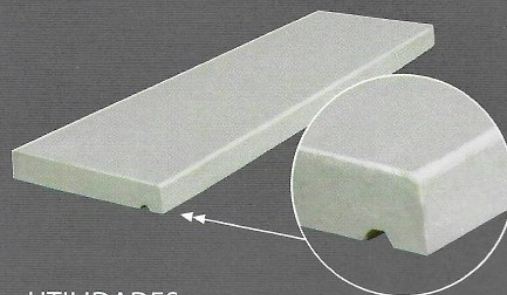

UTILIDADES

Formación de ventanas.
Decoración de la fachada del inmueble.

COLORES *  BLANCO  GRIS  TOSTADO

>> CON TACÓN

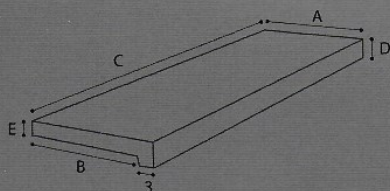

A	B	D	E
16	13	6	3
20	17	6	3
22	19	6	3
26	23	6	3
28	25	6	3
32	29	6	3
35	32	6	3
40	37	6	3
42	39	6	3
45	42	6	3
50	47	6	3

>> PLANO CON GOTERÓN

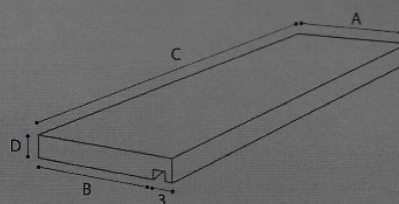

A	B	D
16	13	3/4/5/6
20	17	3/4/5/6
22	19	3/4/5/6
26	23	3/4/5/6
28	25	3/4/5/6
32	29	3/4/5/6
35	32	3/4/5/6
40	37	3/4/5/6
42	39	3/4/5/6
45	42	3/4/5/6
50	47	3/4/5/6

NOTA: Los alfeizares con tacón o goterón, se fabrican con la longitud y anchura deseadas por el cliente. * Se fabrica en cualquier color.

www.mosaicsplanas.com

 planas@mosaicsplanas.com  972 840 216

PRODUCTO DE HORMIGÓN

MOSAICSPLANAS

>> ALBARDILLAS en forma de U

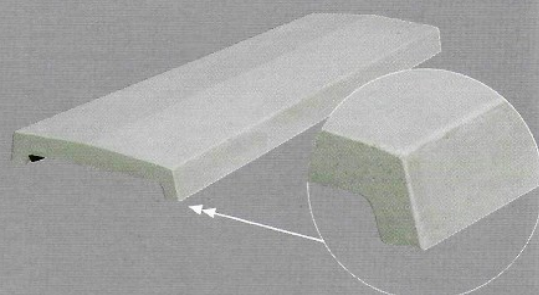
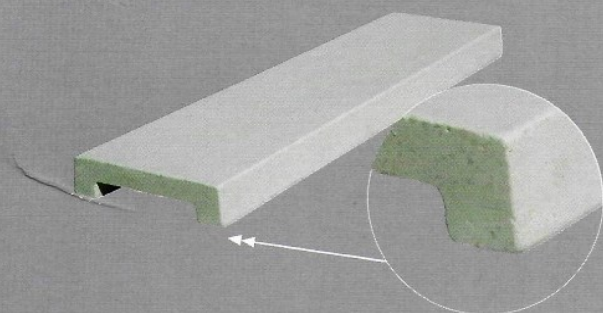



CARACTERÍSTICAS

COTAS: En centímetros.

UTILIDADES

Formación de muros.
Decoración de la fachada del inmueble.

COLORES *  BLANCO  GRIS  TOSTADO

>> EN FORMA DE U

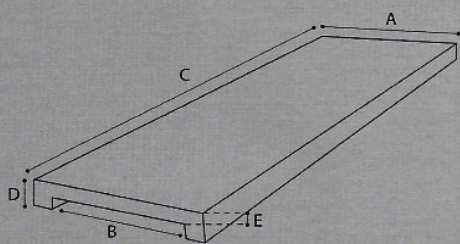

A	B	C	D	E
20	14	100	6	3
22	16	100	6	3
26	20	100	6	3
32	26	100	6	3
36	30	100	6	3
42	36	100	6	3

>> A DOS AGUAS EN FORMA DE U

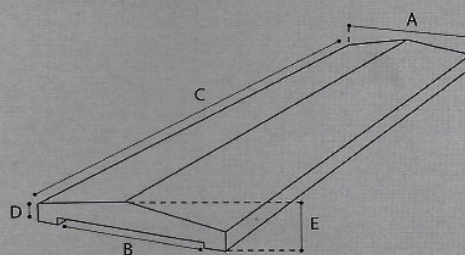

A	B	C	D	E
20	14	100	6	9
22	16	100	6	9
26	20	100	6	9
32	26	100	6	9
36	30	100	6	9
42	36	100	6	9

* Se fabrica en cualquier color.

www.mosaicsplanas.com

 planas@mosaicsplanas.com

 972 840 216

PRODUCTO DE HORMIGÓN

MOSAICSPLANAS

>> CUBREPILARES

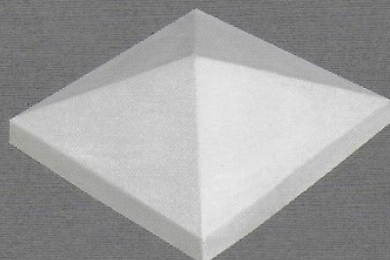



CARACTERÍSTICAS

COTAS: En centímetros.

UTILIDADES

Decoración de pilares.

COLORES *  BLANCO  GRIS  TOSTADO

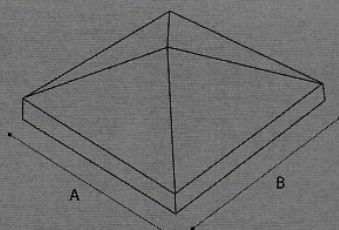

A	B
30	30
35	35
40	40
45	45
50	50
55	55

* Se fabrica en cualquier color.

www.mosaicsplanas.com

 planas@mosaicsplanas.com

 972 840 216